



TOASTER OVEN

Model Number: 169157

UPC: 0681131691574

Customer Assistance

1 877 207 0923 (US)

1 877 556 0973 (Canada)



Thank you for purchasing a GE small appliance. In keeping with the GE ecomagination initiative, please consider the option to recycle the packaging material and donate the appliance you are no longer using.

To read about GE's ecomagination commitment, visit
<http://ge.ecomagination.com>

IMPORTANT SAFEGUARDS

When using electrical appliances, basic safety precautions should always be followed, including the following:

- Read all instructions.
- Crumb tray should not be removed until the unit has cooled down.
- Do not touch hot surfaces. Use handles or knobs.
- To protect against electrical shock, do not immerse cord, plug or oven in water or other liquid.
- Close supervision is necessary when any appliance is used by or near children.
- Unplug unit from the outlet when not in use and before cleaning. Allow to cool before putting on or taking off parts and before cleaning.
- Do not operate appliance with a damaged cord or plug, or after the appliance malfunctions or has been damaged in any manner. No user-serviceable parts inside. Call our toll-free customer service number for information on examination, repair or adjustment.
- The use of accessory attachments not recommended or sold by the manufacturer may cause injuries.
- Do not use outdoors.
- Do not let cord hang over edge of table or counter, or touch hot surfaces.
- Do not place on or near a hot gas or electric burner, or in a heated oven.
- Extreme caution must be used when moving an appliance containing hot oil or other hot liquids.
- Use extreme caution when removing rack, bake tray, drip pan, crumb tray or disposing of hot grease. Always use oven mitts or hot pads when removing items from the oven.
- Oversize foods or metal utensils must not be inserted in the halogen oven as they may create a fire or risk of electric shock.
- A fire may occur if the halogen oven is covered or touching flammable material, including curtains, draperies, walls, and the like, when in operation. Do not store any item on top of the appliance when in operation.
- Do not clean with metal scouring pads. Pieces can break off the pad and touch electrical parts creating a risk of electric shock.
- Extreme caution should be exercised when using containers constructed of other than metal or glass.
- Do not store any materials, other than manufacturers recommended accessories, in this oven when not in use.
- Do not place any of the following materials in the oven; paper, cardboard, plastic, any other material that may catch fire or melt.
- Do not cover crumb tray or any part of the oven with metal foil. This will cause overheating of the oven.
- To disconnect, press the Stop key twice, then remove the plug from wall outlet.
- Do not use appliance for other than intended use.
- For Household Use Only.

SAVE THESE INSTRUCTIONS!

This appliance is for **HOUSEHOLD USE ONLY**. It may be plugged into an AC electrical outlet (ordinary household current). Do not use any other electrical outlet.

DO NOT OPERATE APPLIANCE IF THE LINE CORD SHOWS ANY DAMAGE, OR IF APPLIANCE WORKS INTERMITTENTLY OR STOPS WORKING ENTIRELY.

A short power-supply cord is provided to reduce the risk resulting from becoming entangled in or tripping over a longer cord. Longer detachable power-supply cords or extension cords are available and may be used if care is exercised in their use. If a longer detachable power-supply cord or extension cord is used;

- 1) The marked electrical rating of the cord set or extension cord should be at least as great as the electrical rating of the appliance, and
- 2) The cord should be arranged so that it will not drape over the countertop or tabletop where it can be pulled on by children or tripped over unintentionally.

If the power-supply cord is a grounding-type-3-wire cord with a grounding prong on the plug, the extension cord should also be a grounding-type-3-wire cord.

GROUNDING INSTRUCTIONS

This appliance must be grounded while in use to protect the operator from electrical shock. The appliance is equipped with a 3-conductor cord and a 3-prong grounding-type plug to fit the proper grounding-type receptacle.

GROUNDING INSTRUCTIONS – US ONLY

The appliance has a plug that looks like Figure A. An adaptor, as shown in Figure B, should be used for connecting a 3-prong grounding plug to a 2-ground receptacle. The grounding tab, which extends from the adaptor, must be connected to a permanent ground such as a properly grounded outlet box as shown in Figure C, using a metal screw.

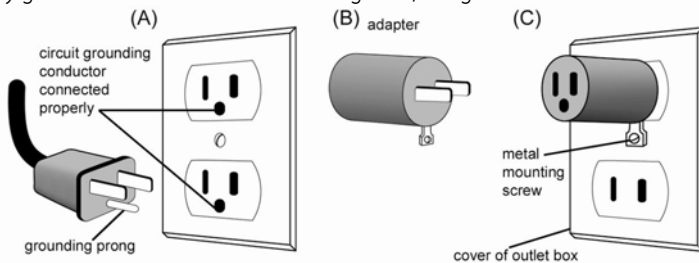

LINE CORD SAFETY TIPS

1. Never pull or yank on cord or the appliance.
2. To insert plug, grasp it firmly and guide it into outlet.
3. To disconnect appliance, grasp plug and remove it from outlet.
4. Before each use, inspect the line cord for cuts and/or abrasion marks. If any are found, this indicates that the appliance should be serviced and the line cord replaced.
5. Never wrap the cord tightly around the appliance, as this could place undo stress on the cord where it enters the appliance and cause it to fray and break.

PARTS



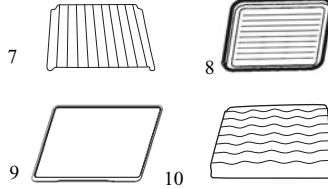
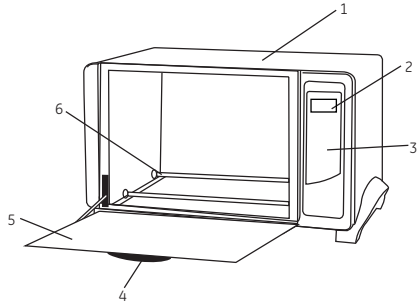

PARTS

NAME OF PARTS

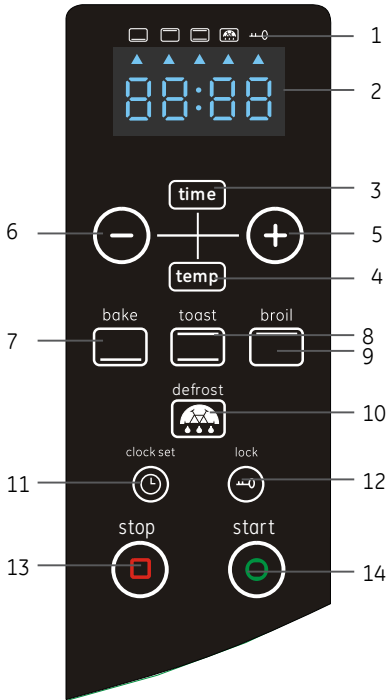
1. Housing
2. Digital display
3. Control panel
4. Door handle
5. Door glass
6. Heating elements
7. Baking rack
8. Baking pan
9. Crumb tray
10. Broil rack





1. Function icon
 -  Bake
 -  Broil
 -  Toast
 -  Defrost
 -  Lock
2. Digital display
3. Time setting
4. Temperature setting
5. Time/Temp+
6. Time/Temp-
7. Bake Function
8. Toast Function
9. Broil Function
10. Defrost Function
11. Clock Setting
12. Lock Function
13. Stop
14. Start

INSTRUCTIONS FOR USE

For your safety, always read and understand this Instruction Manual before attempting to use the Toaster Oven.

Before Using:

1. Carefully unpack the oven. Remove all packaging materials.
2. Wash the baking rack, bake pan, crumb tray and broil rack in warm soapy water. Dry thoroughly.
3. Wipe exterior surfaces of the oven with a soft, moist cloth to remove dust particles collected during packing and handling. Dry thoroughly. Do not use abrasive cleaners. NEVER IMMERSE THE OVEN, CORD OR PLUG IN WATER OR ANY OTHER LIQUID.
4. Place oven on a flat counter or other stable surface.
5. Be sure all parts are properly assembled and in place before use.
6. On initial use, Set function to Toast and the darkest setting (See page 8). This will burn off any residue or oils still on the oven. **Note:** The oven may smoke during this process. This is normal and will not last longer than 10-15 minutes.
7. Your oven is now ready to use.

FUNCTION

Defrost: The upper and lower heating elements are operating to warm and defrost frozen food.

Bake: The lower heating elements are operating during this function.

Broil: The upper heating elements are operating during this cycle.

Toast: The upper and lower heating elements are operating during this function.

CAUTION: THE OVEN SURFACES ARE HOT DURING AND AFTER USE

CRUMB TRAY SHOULD NOT BE REMOVED UNTIL THE UNIT HAS COOLED DOWN.

Important notes:

1. Place the Baking Rack in a position that will accommodate the height of the food to be cooked.
2. Set the food on the Baking Rack or Baking Pan. Make sure that you always use an ovenproof container in the oven. Never use plastic or cardboard containers in the Oven
3. Never use glass or ceramic pans or lids.
4. DO NOT let juices run to the bottom of the oven. Use the Crumb Tray when cooking.
5. Follow recipe instructions when setting the temperature.
6. While operating, press the Stop button once to Pause (LED will flash). Press Start to resume cooking. Press stop twice to turn Toaster Oven off.

OPERATING INSTRUCTIONS

When plugged in, the LED will display: "00:00"

Clock setting

1. Plug oven into wall outlet.
2. Press the clock key and then press the "+" or "-" keys to adjust to the correct hour. Press the clock key again and use the "+" or "-" keys to adjust to the correct minute.
3. Press the clock key a third time to set the clock.

Note: (For all cooking functions)

CHILD LOCK

1. When not in use, press the "Lock" button and hold for 3 seconds, a long beep will sound. The unit is now locked and cannot be used.
2. To unlock, press the "lock" button and hold for 3 seconds until a long beep sounds. The unit is now unlocked.

STOP/PAUSE

While operating, press the Stop button once to Pause (LED will flash).

Press Start to resume cooking. Press Stop twice to turn Toaster Oven off.

Time setting

1. The cooking time range is 30 seconds~99 minutes.
2. While cooking, you can press "Time" button and adjust by pressing the "+" or "-" button.
3. Note: For rapid time and temperature advance, press and hold the "+" or "-" button.

Temperature setting

1. Adjust the temperature by the "+" or "-" button. The temperature will increase or decrease in 25 degrees F or 15 degrees C increments.
2. Cooking temperature range is 150 ~450F (65 ~230C).
3. When the desired temperature has been reached, press "+" or "-". The temperature will cycle within the selected temperature range.
4. While cooking, you can press the "Temp" button and adjust the temperature by pressing the "+" or "-" button.

NOTE: Default temperature is Fahrenheit. For rapid time and temperature advance, press and hold the "+" or "-" button. Press and hold the "Temp" button for Celsius.

DEFROST FUNCTION

1. Press "Defrost", to display the default defrost time, "30:00".
2. Press "+" or "-" to adjust the defrost time.
3. Press "Start". Toaster Oven will beep once and begin defrosting.
4. When complete, Toaster Oven will beep three times. The LED indicates "00:00" or current time.

Note: To stop at any time, press the Stop button twice. Defrost temperature cannot be adjusted. Default temperature is 200 degrees F.

BAKE/BROIL FUNCTION:

1. Press "Bake" or "Broil", the default time is "30:00".
2. Press "+" or "-" to adjust time.
3. Press the "temp" button, and then press "+" or "-" to adjust temperature.
4. Press "Start". Toaster Oven will beep once and begin cooking.
5. When complete, Toaster Oven will beep three times. The LED indicates "00:00" or current time.

Note: To stop at any time, press the Stop button twice.

TOAST SETTING :

Light setting: Select Toast once. A single bar is displayed.

Medium Setting: Select Toast twice. Two bars are displayed.

Dark Setting: Select Toast three times. Three bars are displayed.

1. Press the start key. The oven will begin operating and the display will show the time counting down. When the time reaches 00:00, the oven cycle is complete and you will here 3 audible tones.

Note: To stop at any time, press the stop button twice. The Toast time and temperature cannot be adjusted.

CLEANING AND STORAGE

This appliance requires little maintenance. It contains no user-serviceable parts. Do not attempt to repair it yourself. Any servicing that requires disassembly, other than cleaning, must be performed by a qualified appliance repair technician.

To Clean:

1. Unplug unit and allow to cool completely. After each use, when oven has cooled, clean food particles off with a damp sponge or cloth. **Never immerse oven in water or any other liquid.** Do not use abrasive cleaners, as they may damage unit.
2. Wash baking rack, baking pan, broil rack and crumb tray in warm soapy water.

To Store:

Be sure all parts are clean and dry before storing. Store appliance in its box or in a clean, dry place. Never wrap cord tightly around the appliance; keep it loosely coiled or use the cord wrap behind the oven.

CUSTOMER ASSISTANCE

For faster service, please have the model number and product name ready for the operator to assist you. This number can be found on the bottom of your appliance and on the front page of this manual

Model Number: _____ **Product Name:** _____

Customer Assistance Number 1-877-207-0923[U.S.] or 1-877-556-0973 (Canada)

Keep these numbers for future reference!

For more information, Please visit us at www.gehousewares.com

TWO-YEAR LIMITED WARRANTY

What does your warranty cover?

- Any defect in material or workmanship.
For how long after the original purchase?
- Two years. What will we do?
- Provide you with a new one.
- For those items still under warranty but no longer available. WAL-MART reserves the right to replace with a similar GE branded product of equal or greater value.

How do you make a warranty claim?

- Save your receipt.
- properly pack your unit we recommend using the original carton and packing materials.
- Return the product to your nearest WAL-MART store or call customer Assistance at 1-877-207-0923[U.S.] Or 1-877-556-0973(Canada).

What does your warranty not cover?

- Parts subject to wear, including, without limitation, glass parts, glass containers, cutter/strainer, blades, seals, gaskets, clutches, motor brushes, and/or agitators, etc.
- Commercial use or any other use not found in printed directions.
- Damage from misuse, abuse or neglect, including failure to clean product regularly in accordance with manufacturer's instructions.

How does state law relate to this warranty?

- This warranty gives you specific legal rights, and you may also have other rights which vary from state to state or province to province.
- This warranty is in lieu of any other warranty or condition, whether express or implied, written or oral, including. Without limitation, any statutory warranty or condition of merchantability or fitness for a particular purpose.
- WAL-MART, GE and the product manufacturer expressly disclaim all responsibility for special, incidental and consequential damages or losses caused by use of this appliance. Any liability is expressly limited to an amount equal to the purchase price paid whether a claim, however instituted, is based on contract, indemnity, warranty, tort including negligence strict liability, or otherwise. Some states or provinces do not allow this exclusion or limitation of incidental or consequential losses so the foregoing disclaimer may not apply to you.

What if you encounter a problem with this product while using it outside the country of purchase?

- The warranty is valid only in the country of purchase and you follow the warranty claim procedure as noted.



is a trademark of General Electric company and is used under the license by Wal-Mart Stores Inc, Bentonville, AR 72716

Marketed in Canada by Wal-Mart Canada Corp
1940 Argentia Road, Mississauga, Ontario L5N1P9